

12-18 WEDGE PRESS 2X4 COMBO

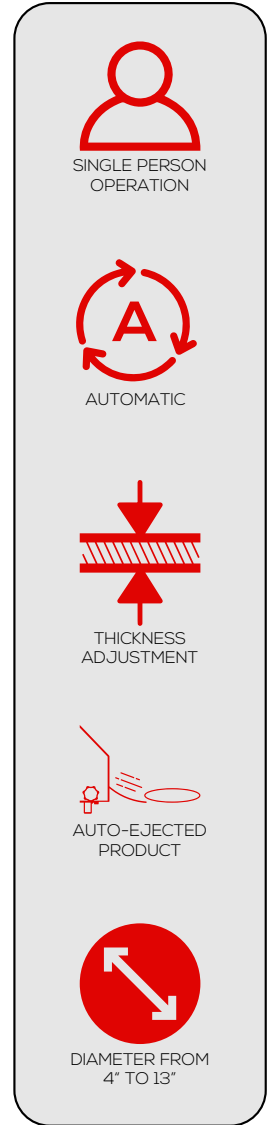

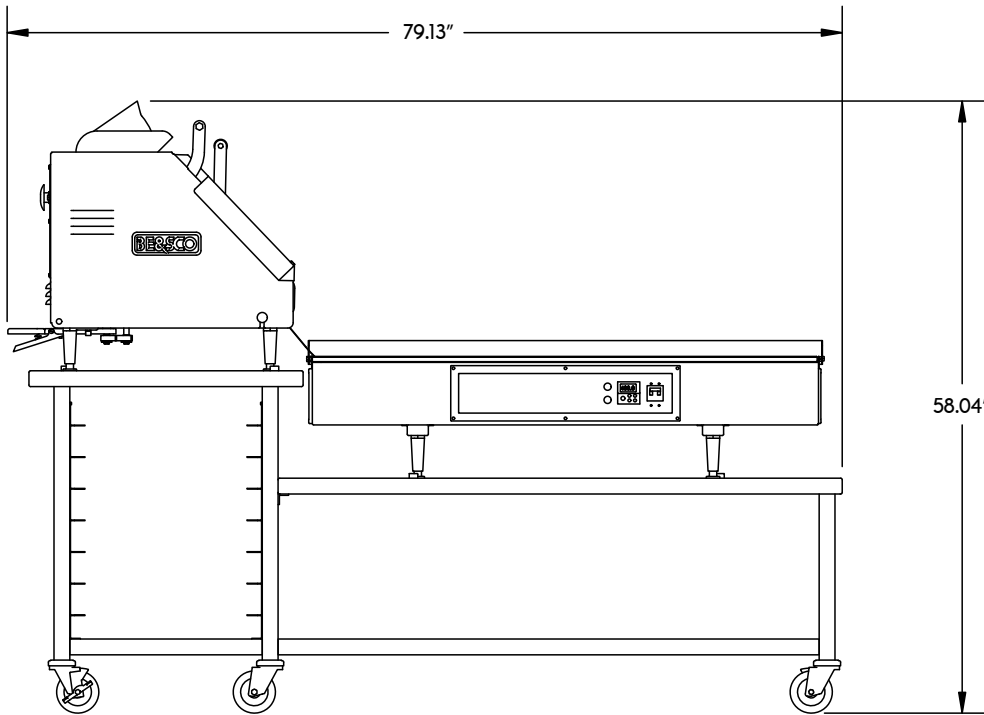

AUTOMATIC FLATBREAD PRESS, GRILL & STAND

SIDE VIEW

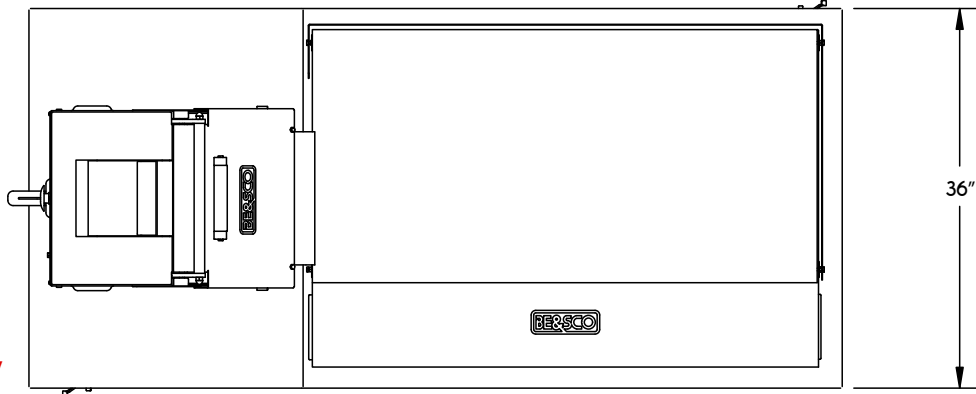

TOP VIEW



DIMENSIONS W/ GRILL	79.13" L X 36" W X 58.04" H	PRESS ELECTRICAL	 PLUG: NEMA 10-50P (250V~)  RECEPTACLE: NEMA 10-50R (250V~)
		GRILL ELECTRICAL	 PLUG: NEMA 14-60P (125-250V~)  RECEPTACLE: NEMA 14-60R (125-250V~)



*Certifications Applicable to Press and Grill Only. Certifications Not Applicable to Stands.

**Production may vary due to the operator experience, diameter and thickness of product.

BE&SCO EQUIPMENT IS SOLELY INTENDED FOR USE IN A COMMERCIAL FACILITY.



REVISED: 02/25/2021