

# STAND ALONE MIDWEDGE 2X2 COMBO

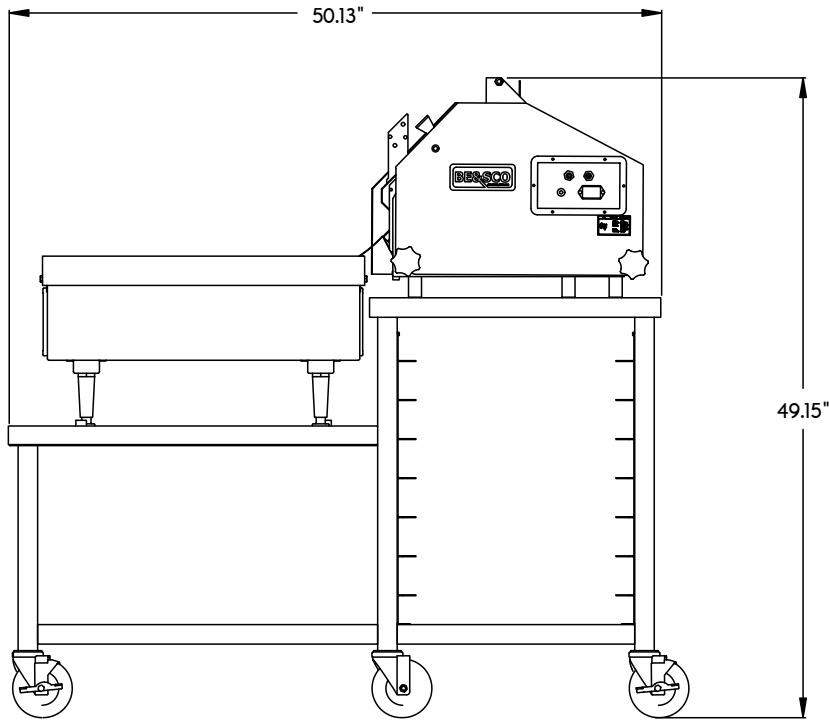



## AUTOMATIC FLATBREAD PRESS, GRILL & STAND



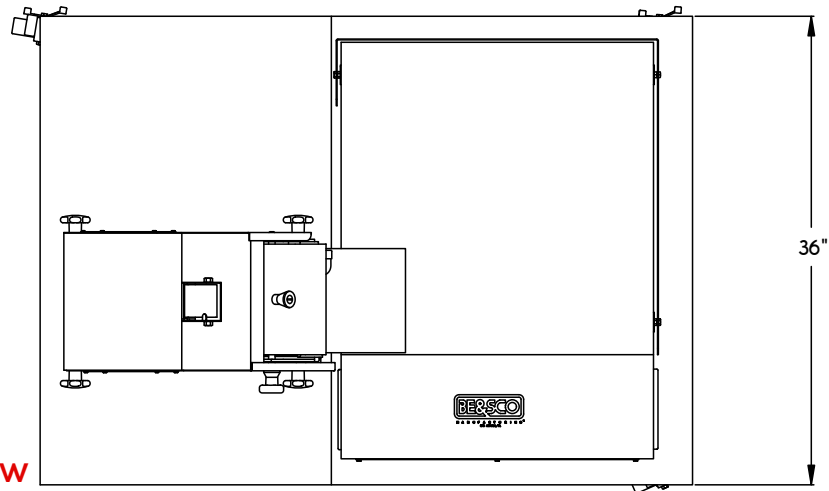

SIDE VIEW

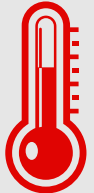

TOP VIEW



-   
 SINGLE PERSON OPERATION
-   
 AUTOMATIC
-   
 TEMPERATURE CONTROLLED PLATES
-   
 AUTO-EJECTED PRODUCT
-   
 DIAMETER FROM 4" TO 7"

<b>DIMENSIONS W/ GRILL</b>	50.13" L X 36" W X 49.15" H	<b>PRESS ELECTRICAL</b>	 <b>PLUG:</b> NEMA 5-20P (125V~)  <b>RECEPTACLE:</b> NEMA 5-20R (125V~)
		<b>GRILL ELECTRICAL</b>	 <b>PLUG:</b> NEMA 10-50P (250V~)  <b>RECEPTACLE:</b> NEMA 10-50R (250V~)



\*Certifications Applicable to Press and Grill Only. Certifications Not Applicable to Stands.  
 \*\*Production may vary due to the operator experience, diameter and thickness of product.  
 BE&SCO EQUIPMENT IS SOLELY INTENDED FOR USE IN A COMMERCIAL FACILITY.



REVISED: 02/26/2021