

STAND ALONE MIDWEDGE 2X4 COMBO

AUTOMATIC FLATBREAD PRESS, GRILL & STAND

SIDE VIEW

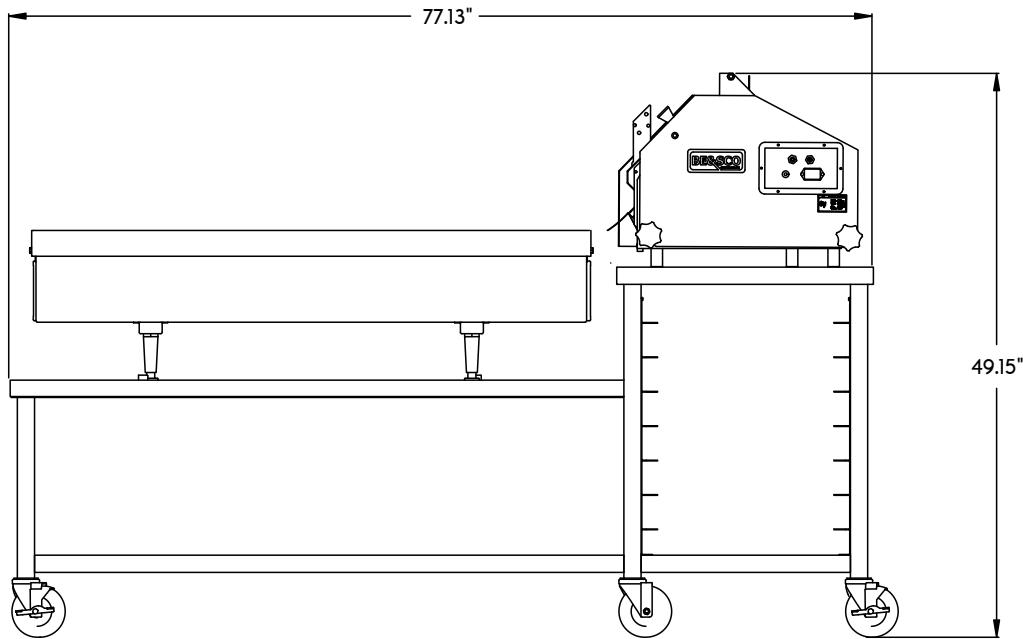

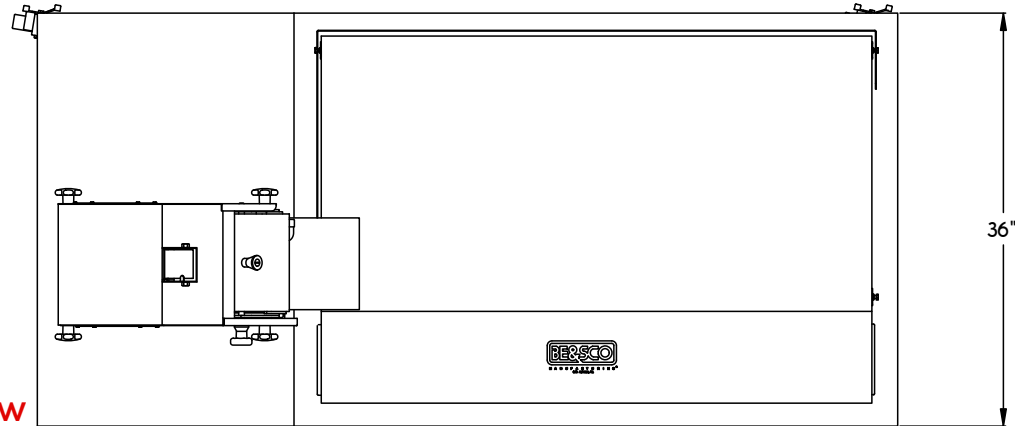

TOP VIEW



- 

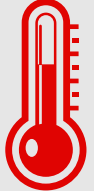



SINGLE PERSON OPERATION
- 

AUTOMATIC
- 

TEMPERATURE CONTROLLED PLATES
- 

AUTO-EJECTED PRODUCT
- 

DIAMETER FROM 4" TO 7"

DIMENSIONS W/ GRILL	77.13" L X 36" W X 49.15" H	PRESS ELECTRICAL	 PLUG: NEMA 5-20P (125V~)  RECEPTACLE: NEMA 5-20R (125V~)
		GRILL ELECTRICAL	 PLUG: NEMA 14-60P (125-250V~)  RECEPTACLE: NEMA 14-60R (125-250V~)



*Certifications Applicable to Press and Grill Only. Certifications Not Applicable to Stands.

**Production may vary due to the operator experience, diameter and thickness of product.

BE&SCO EQUIPMENT IS SOLELY INTENDED FOR USE IN A COMMERCIAL FACILITY.



REVISED: 02/26/2021