

STAND ALONE MIDWEDGE 2X4 COMBO

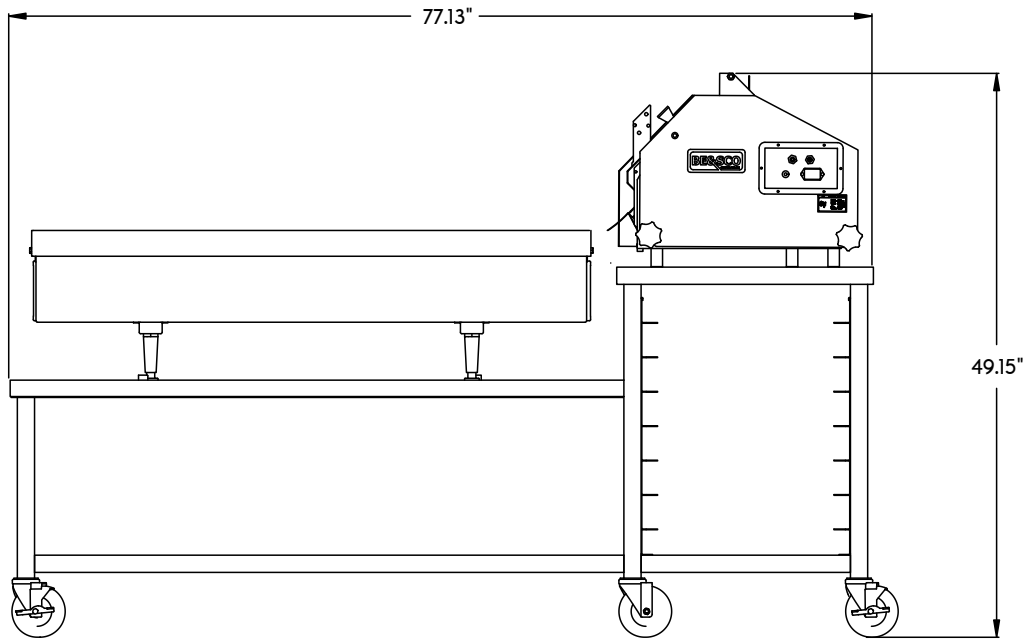



AUTOMATIC FLATBREAD PRESS, GRILL & STAND



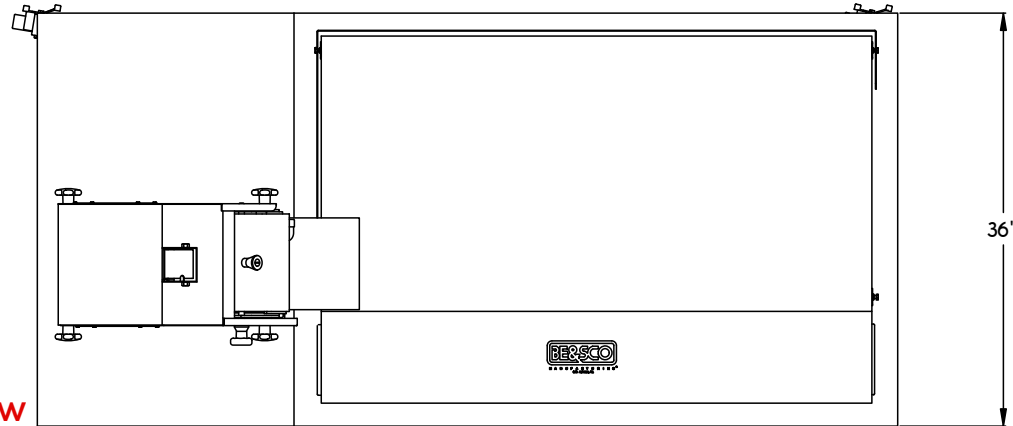

SIDE VIEW

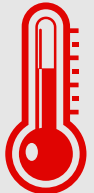

TOP VIEW



- 
 SINGLE PERSON OPERATION
- 
 AUTOMATIC
- 
 TEMPERATURE CONTROLLED PLATES
- 
 AUTO-EJECTED PRODUCT
- 
 DIAMETER FROM 4" TO 7"

DIMENSIONS W/ GRILL	77.13" L X 36" W X 49.15" H	PRESS ELECTRICAL	 PLUG: NEMA 6-20P (250V~)  RECEPTACLE: NEMA 6-20R (250V~)
		GRILL ELECTRICAL	 PLUG: NEMA 14-60P (125-250V~)  RECEPTACLE: NEMA 14-60R (125-250V~)



*Certifications Applicable to Press and Grill Only. Certifications Not Applicable to Stands.

**Production may vary due to the operator experience, diameter and thickness of product.

BE&SCO EQUIPMENT IS SOLELY INTENDED FOR USE IN A COMMERCIAL FACILITY.



REVISED: 02/26/2021