

WEDGE PRESS ROTOMAL COMBO

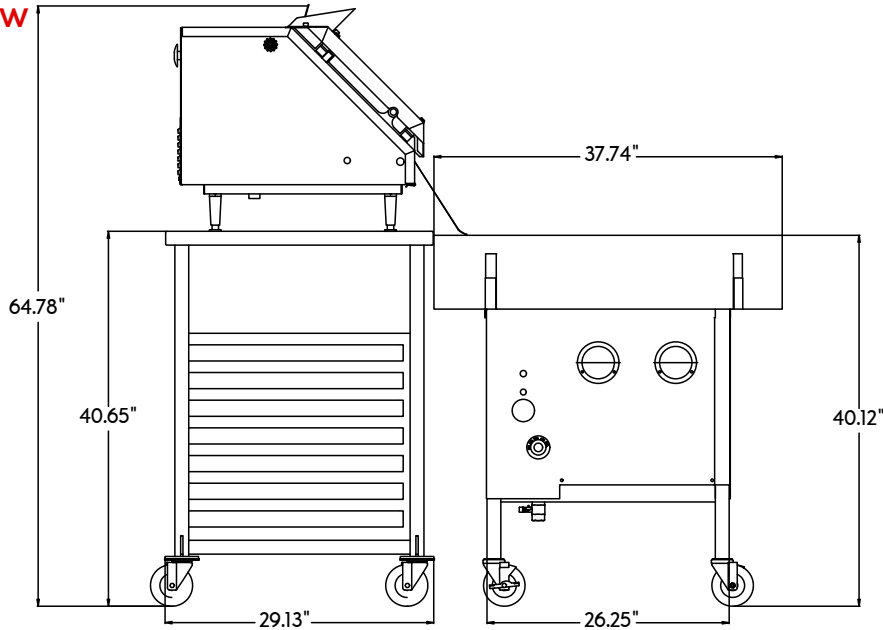



AUTOMATIC FLATBREAD PRESS, GRILL & STAND



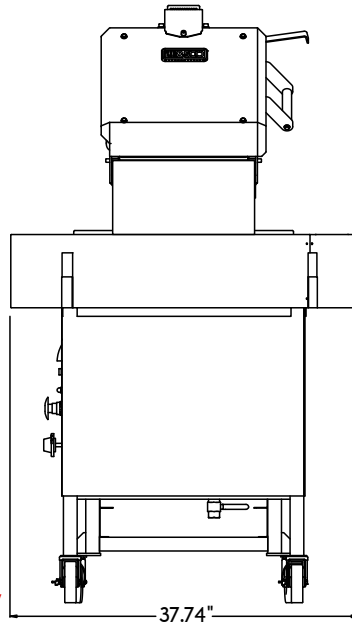

SIDE VIEW

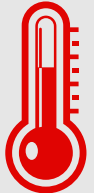

FRONT VIEW



- 
 SINGLE PERSON OPERATION
- 
 AUTOMATIC
- 
 TEMPERATURE CONTROLLED PLATES
- 
 AUTO-EJECTED PRODUCT
- 
 DIAMETER FROM 4" TO 12"

DIMENSIONS W/ GRILL	66.8" L X 37.7" W X 64.7" H	PRESS ELECTRICAL	 PLUG: NEMA 10-50P (250V~)  RECEPTACLE: NEMA 10-50R (250V~)
		GRILL ELECTRICAL	 PLUG: NEMA 5-20P (125V~)  RECEPTACLE: NEMA 5-20R (125V~)



*CE Certification Applicable to Press Only. ETL and NSF Certifications Applicable to Press and Grill Only. Certifications Not Applicable to Stand.

**Production may vary due to the operator experience, diameter and thickness of product.

BE&SCO EQUIPMENT IS SOLELY INTENDED FOR USE IN A COMMERCIAL FACILITY.



REVISED: 03/05/2021